

Surgrappe - (carré)
possible en 1/4

Bolide ...

8 roues, 1/4, 1/2, 3/4, 1

Les solides représentés ci-dessous en perspective cavalière sont des prismes droits ou des cylindres de révolution. Construire en vraie grandeur ces solides puis, les assembler pour construire un bolide.

Avant

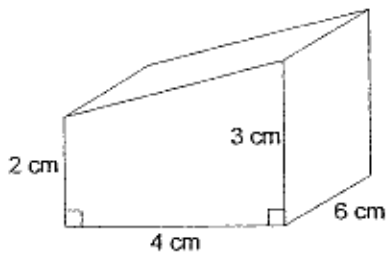

Pare-brise

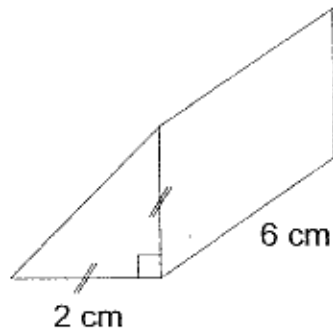

Roues

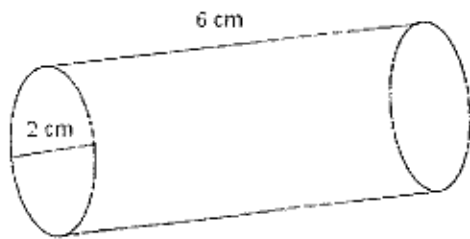

Portière bas

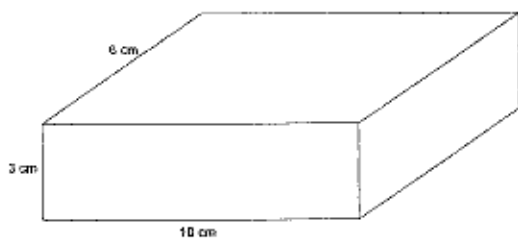

Portière haut

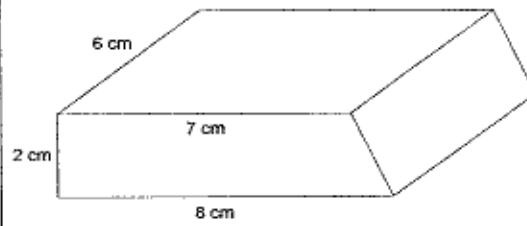

Coffre

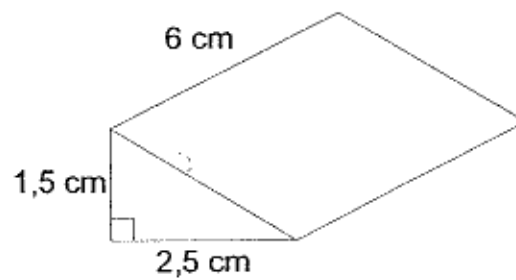

Roues

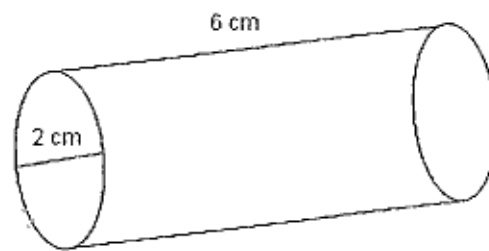

Pare-choc arrière

